

THIS DRAWING IS UNPUBLISHED. RELEASED FOR PUBLICATION 20
 © COPYRIGHT 20 BY - ALL RIGHTS RESERVED.

REVISIONS					
P	LTR	DESCRIPTION	DATE	DWN	APVD
A		RELEASED PER ECO-17-008656	15JUN2017	CJV	EDB
B		REVISED PER ECO-17-014247	21SEP2017	MS	MP

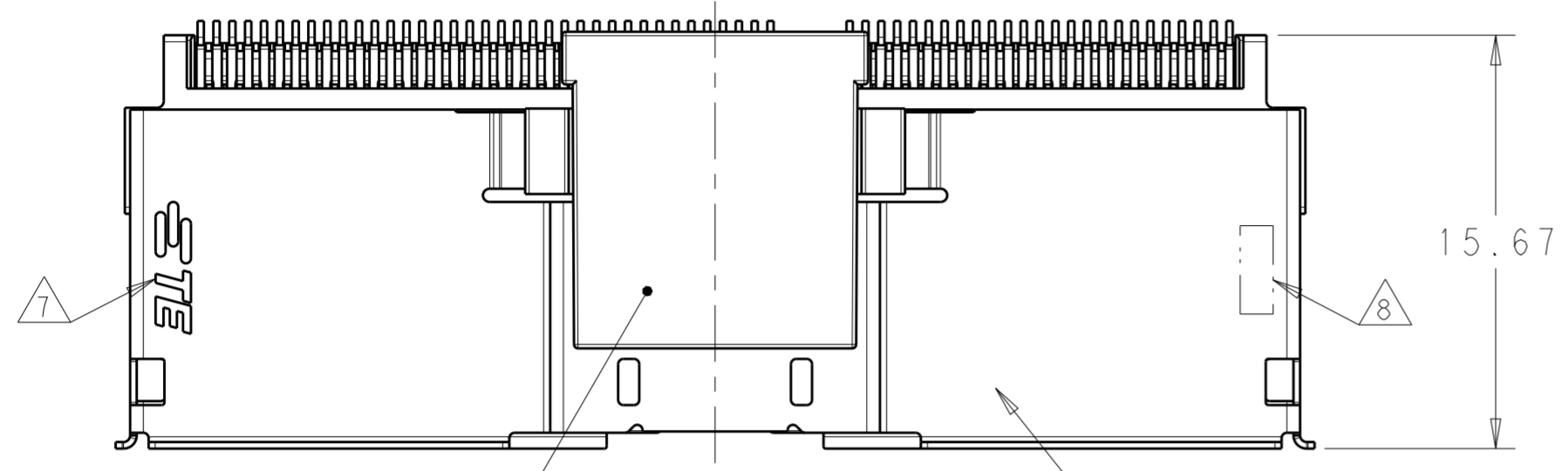

PICK AND PLACE CAP SHELL

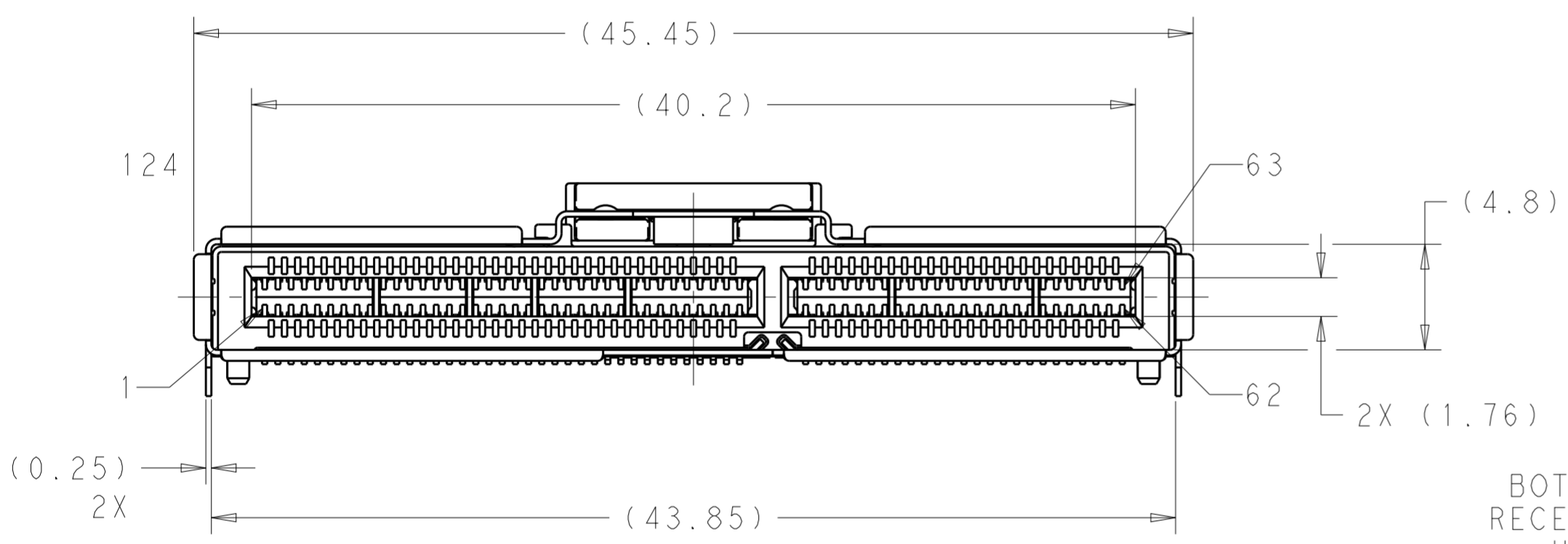

BOTTOM OF RECEPTACLE HOUSING

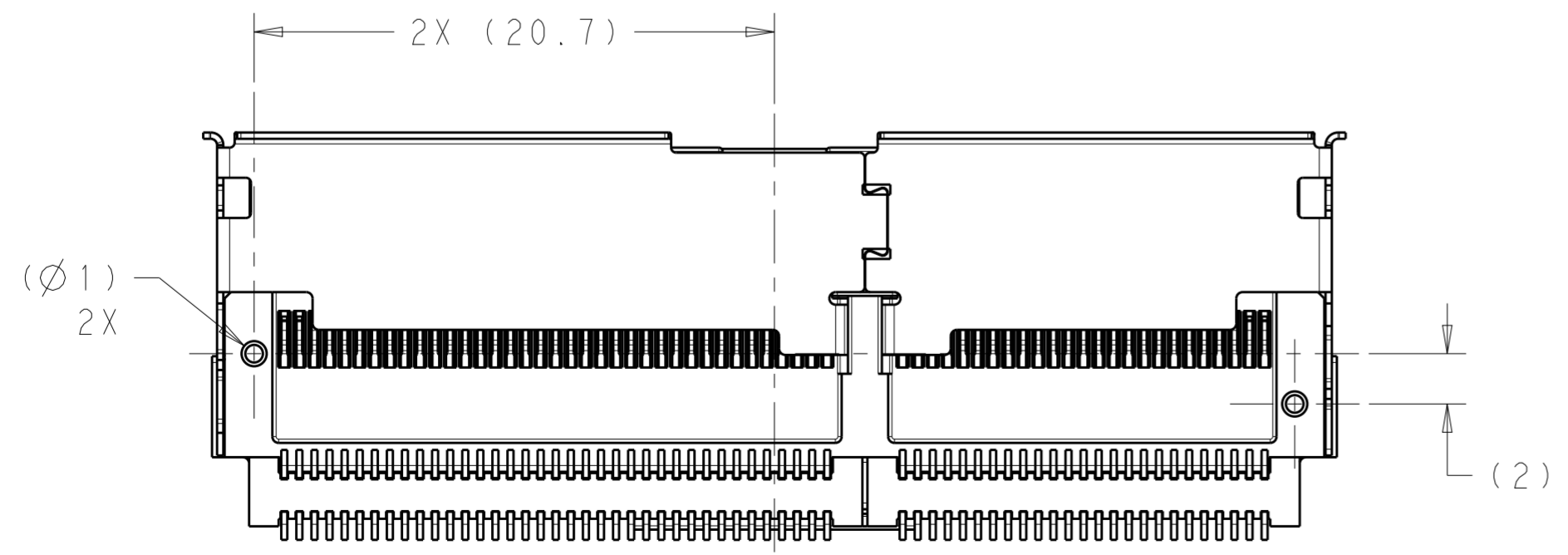

- 1 HOUSING, ORGANIZER AND CONTACT OVERMOLD: LCP, BLACK.
CONTACTS: COPPER ALLOY.
SHELL: COPPER ALLOY, NICKEL PLATED. TIN PLATED ON HOLD DOWNS.
PICK AND PLACE CAP: LCP, BLACK.
- 2 GOLD PLATED ON MATING INTERFACE. TIN PLATED ON SOLDER TAILS.
- 3 DATUM AND BASIC DIMENSION ESTABLISHED BY CUSTOMER.
- 4. MINIMUM PC BOARD THICKNESS:
SINGLE SIDED = 1.42 MIN.
DOUBLE SIDED = 2 MIN.
- 5 RECOMMENDED COMPONENT KEEP OUT AREA.
- 6 RECOMMENDED COMPONENT AND TRACES KEEP OUT AREA.
- 7 TE CONNECTIVITY LOGO MARKED IN APPROXIMATE AREA SHOWN.
- 8 PART NUMBER AND DATE CODE MARKED IN APPROXIMATE AREA SHOWN.
- 9 MAY INCLUDE COMPONENTS FABRICATED WITH PRE-PRODUCTION TOOLS.
- 10 COMPONENTS FABRICATED WITH PRODUCTION TOOLS.

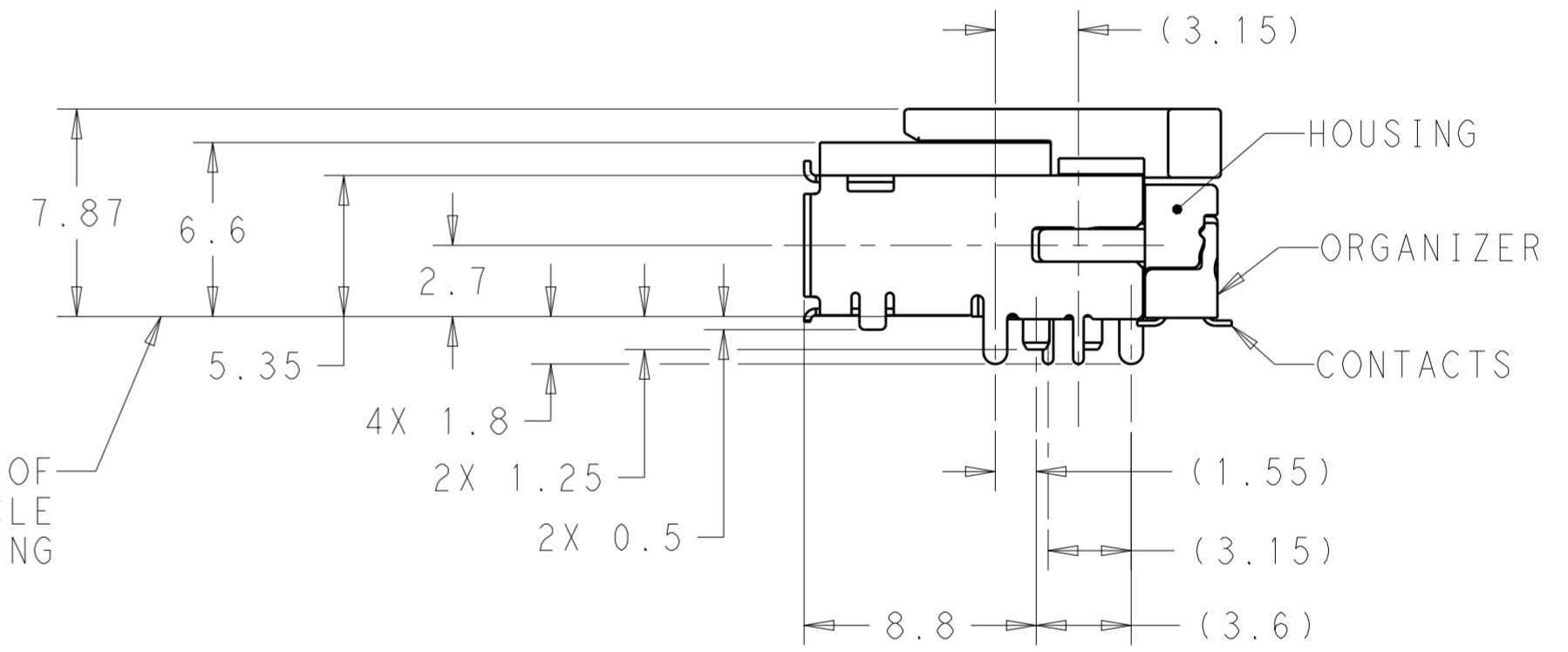

10	2294190-3
9	2294190-2
OBSOLETE	2294190-1
DESCRIPTION	PART NUMBER

THIS DRAWING IS A CONTROLLED DOCUMENT.		DWN M. SHIRK 07 JUL 2015	TE Connectivity	
DIMENSIONS: mm		CHK M. PHILLIPS 07 JUL 2015		
TOLERANCES UNLESS OTHERWISE SPECIFIED:		APVD -	NAME RECEPTACLE CONNECTOR, RIGHT ANGLE, 124 POSITION, SLIVER	
0 PLC ±0.15	1 PLC ±0.15	PRODUCT SPEC -	SIZE A2	CAGE CODE -
2 PLC ±0.15	3 PLC ±	APPLICATION SPEC -	DRAWING NO. C-2294190	RESTRICTED TO -
4 PLC ±	ANGLES ±	WEIGHT -	SCALE 4:1	SHEET 1 OF 3
FINISH		CUSTOMER DRAWING	REV B	

THIS DRAWING IS UNPUBLISHED. RELEASED FOR PUBLICATION 20
 © COPYRIGHT 20 BY - ALL RIGHTS RESERVED.

REVISIONS				
P	LTR	DESCRIPTION	DATE	APVD
-	-	SEE SHEET 1	-	-

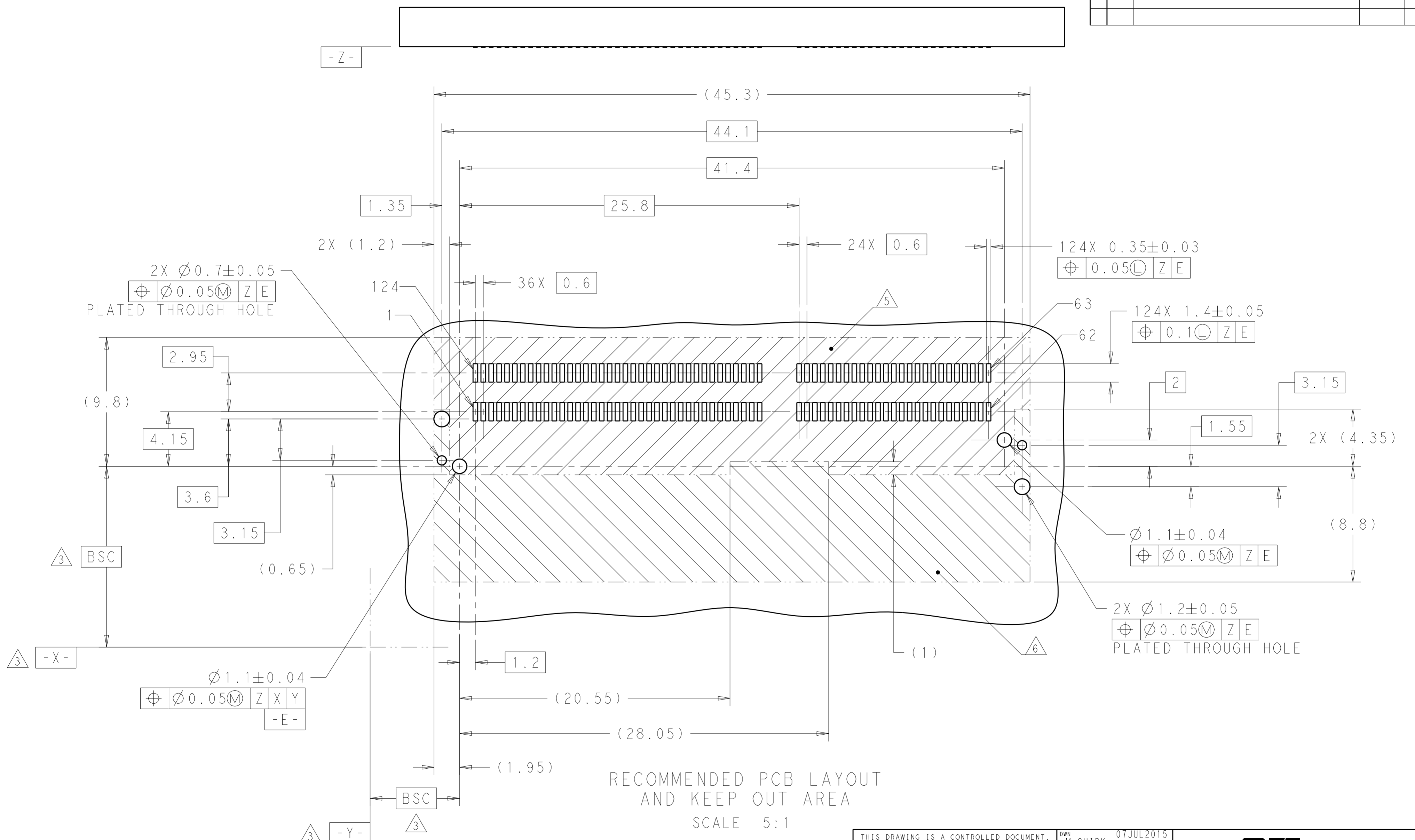

RECOMMENDED PCB LAYOUT
 AND KEEP OUT AREA
 SCALE 5:1

THIS DRAWING IS A CONTROLLED DOCUMENT.		DWN M. SHIRK 07 JUL 2015	 TE Connectivity	
		CHK M. PHILLIPS 07 JUL 2015		
DIMENSIONS: mm		TOLERANCES UNLESS OTHERWISE SPECIFIED: 0 PLC ±0.15 1 PLC ±0.15 2 PLC ±0.15 3 PLC ± 4 PLC ± ANGLES ± FINISH ±		NAME RECEPTACLE CONNECTOR, RIGHT ANGLE, 124 POSITION, SLIVER
MATERIAL - -		PRODUCT SPEC - APPLICATION SPEC - WEIGHT -		SIZE A2
		CUSTOMER DRAWING		DRAWING NO. C-2294190
		SCALE 4:1		RESTRICTED TO -
		SHEET 2 OF 3		REV B

THIS DRAWING IS UNPUBLISHED. RELEASED FOR PUBLICATION 20
 © COPYRIGHT 20 BY - ALL RIGHTS RESERVED.

REVISIONS				
P	LTR	DESCRIPTION	DATE	APVD
-		SEE SHEET 1	-	-

PIN #	DESCRIPTION	PIN #	DESCRIPTION
1	SIGNAL GROUND	124	SIGNAL GROUND
2	SIGNAL	123	SIGNAL
3	SIGNAL	122	SIGNAL
4	SIGNAL GROUND	121	SIGNAL GROUND
5	SIGNAL	120	SIGNAL
6	SIGNAL	119	SIGNAL
7	SIGNAL GROUND	118	SIGNAL GROUND
8	SIGNAL	117	SIGNAL
9	SIGNAL	116	SIGNAL
10	SIGNAL GROUND	115	SIGNAL GROUND
11	SIGNAL	114	SIGNAL
12	SIGNAL	113	SIGNAL
13	SIGNAL GROUND	112	SIGNAL GROUND
14	SIGNAL	111	SIGNAL
15	SIGNAL	110	SIGNAL
16	SIGNAL GROUND	109	SIGNAL GROUND
17	SIGNAL	108	SIGNAL
18	SIGNAL	107	SIGNAL
19	SIGNAL GROUND	106	SIGNAL GROUND
20	SIGNAL	105	SIGNAL
21	SIGNAL	104	SIGNAL
22	SIGNAL GROUND	103	SIGNAL GROUND
23	SIGNAL	102	SIGNAL
24	SIGNAL	101	SIGNAL
25	SIGNAL GROUND	100	SIGNAL GROUND
26	SIGNAL	99	SIGNAL
27	SIGNAL	98	SIGNAL
28	SIGNAL GROUND	97	SIGNAL GROUND
29	SIGNAL	96	SIGNAL
30	SIGNAL	95	SIGNAL
31	SIGNAL GROUND	94	SIGNAL GROUND
32	SIGNAL	93	SIGNAL
33	SIGNAL	92	SIGNAL
34	SIGNAL GROUND	91	SIGNAL GROUND
35	SIGNAL	90	SIGNAL
36	SIGNAL	89	SIGNAL
37	SIGNAL GROUND	88	SIGNAL GROUND

PIN #	DESCRIPTION	PIN #	DESCRIPTION
38	SIGNAL GROUND	87	SIGNAL GROUND
39	SIGNAL	86	SIGNAL
40	SIGNAL	85	SIGNAL
41	SIGNAL GROUND	84	SIGNAL GROUND
42	SIGNAL	83	SIGNAL
43	SIGNAL	82	SIGNAL
44	SIGNAL GROUND	81	SIGNAL GROUND
45	SIGNAL	80	SIGNAL
46	SIGNAL	79	SIGNAL
47	SIGNAL GROUND	78	SIGNAL GROUND
48	SIGNAL	77	SIGNAL
49	SIGNAL	76	SIGNAL
50	SIGNAL GROUND	75	SIGNAL GROUND
51	SIGNAL	74	SIGNAL
52	SIGNAL	73	SIGNAL
53	SIGNAL GROUND	72	SIGNAL GROUND
54	SIGNAL	71	SIGNAL
55	SIGNAL	70	SIGNAL
56	SIGNAL GROUND	69	SIGNAL GROUND
57	SIGNAL	68	SIGNAL
58	SIGNAL	67	SIGNAL
59	SIGNAL GROUND	66	SIGNAL GROUND
60	SIGNAL	65	SIGNAL
61	SIGNAL	64	SIGNAL
62	SIGNAL GROUND	63	SIGNAL GROUND

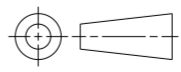
THIS DRAWING IS A CONTROLLED DOCUMENT.		DWN M. SHIRK 07 JUL 2015	 TE Connectivity	
DIMENSIONS: mm		CHK M. PHILLIPS 07 JUL 2015		
		APVD -	NAME RECEPTACLE CONNECTOR, RIGHT ANGLE, 124 POSITION, SLIVER	
TOLERANCES UNLESS OTHERWISE SPECIFIED:		PRODUCT SPEC -	RESTRICTED TO -	
0 PLC ±0.15		APPLICATION SPEC -	SIZE A2	CAGE CODE -
1 PLC ±0.15		WEIGHT -	DRAWING NO C-2294190	SCALE 4:1
2 PLC ±0.15		CUSTOMER DRAWING	SHEET 3 OF 3	REV B
3 PLC ±				
4 PLC ±				
ANGLES ±				
FINISH ±				