

SPECIFICATION

- Part No. : **MA206.A.AB.004**
- Product Name : MA.206 Stingray GPS/2.4~2.54GHz Combination Adhesive Antenna
- Features : GPS/GALILEO - High gain LNA up to 32dB
 2.4~2.5GHz
 Height 10.8mm Diameter 51.7mm
 GPS/GALILEO - Standard 3m RG174 cable and SMA(M) connector
 2.4GHZ - Standard 3m RG174 cable and RF-SMA(M)
 RoHS Compliant



1. Introduction

This is a combination high performance GPS/GALILEO and 2.4~2.5GHz antenna to simplify AVL or Fleet management antenna systems worldwide. Its high quality low profile covert housing can be attached onto the glass or even out of sight under the dashboard. This combination is ideal for those applications that require durability, small size, and covert installation.

Many module manufacturers specify peak gain limits for any antennas that are to be connected to that module. Those peak gain limits are based on free-space conditions. In practice, the peak gain of an antenna tested in free-space can degrade by at least 1 or 2dBi when put inside a device. So ideally you should go for a slightly higher peak gain antenna than mentioned on the module specification to compensate for this effect, giving you better performance.

Upon testing of any of our antennas with your device and a selection of appropriate layout, integration technique, or cable, Taoglas can make sure any of our antennas' peak gain will be below the peak gain limits. Taoglas can then issue a specification and/or report for the selected antenna in your device that will clearly show it complying with the peak gain limits, so you can be assured you are meeting regulatory requirements for that module.

For example, a module manufacturer may state that the antenna must have less than 2dBi peak gain, but you don't need to select an embedded antenna that has a peak gain of less than 2dBi in free-space. This will give you a less optimized solution. It is better to go for a slightly higher free-space peak gain of 3dBi or more if available. Once that antenna gets integrated into your device, performance will degrade below this 2dBi peak gain due to the effects of GND plane, surrounding components, and device housing. If you want to be absolutely sure, contact Taoglas and we will test. Choosing a Taoglas antenna with a higher peak gain than what is specified by the module manufacturer and enlisting our help will ensure you are getting the best performance possible without exceeding the peak gain limits.

The standard version has 3 metres RG174 cable and SMA(M) connector on GPS/GALILEO and RP-SMA(M) on 2.4~2.5GHz. The cables and connectors are completely customizable according to customer request.

Features

GPS/GALILEO

- High LNA Gain up to 32 dB
- Miniaturized to 51.7x10.8mm
- Low Noise 1.5 dB max

Wi-Fi

- Advanced 2.4~2.5GHz

Other

- Water Resistant IP 65
- Quality textured covert design. Low profile
- UV resistant ABS housing
- Comes with high grade 3M double sided tape for quick and easy mounting
- Customizable cables and connectors

2. Specifications

Performance Specifications		
Items	GPS Antenna	2.4~2.5GHz
Features	High performance GPS ceramic patch antenna with cutting edge low noise amplifier	2400MHz to 2500MHz
Frequency	1575.42 MHz ± 2MHz	2.4 – 2.5 GHz
Gain	28dB typ.	0 dB typ.
	Gain at Zenith: -1.0 dBi min	
	Axial Ratio :3.0 dB max	
Noise Figure	2dB max.	-
Polarization	RHCP	Linear
DC Power Input	2.7~3.3V	-
Bandwidth	10 MHz min	100 MHz
VSWR	<=1.92	<=1.92
Impedance	50Ω	50Ω
Cable / Connector	Standard 3m RG-174 Cable SMA(M) Connector	Standard 3m RG-174 Cable RP-SMA(M) Connector
Operating Temperature	-40°C ~ +85°C	-40°C ~ +85°C
Storage Temperature	-40°C ~ +95°C	-40°C ~ +95°C
Size	51.7mm * 10.8mm	
Housing	UV resistant ABS	

***note: specifications may be subject to change**

3. Electrical Characteristic – 2.4~2.5GHz

3.1 Test Setup

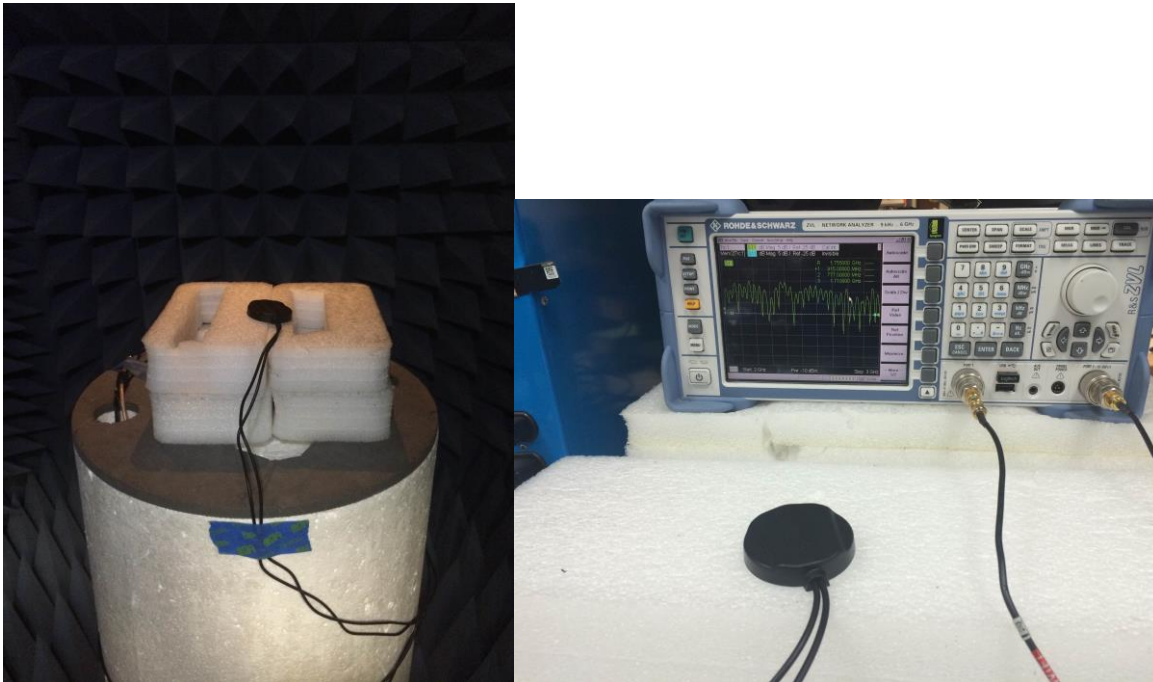

3.2 Return Loss (2.4~2.5GHz Antenna)

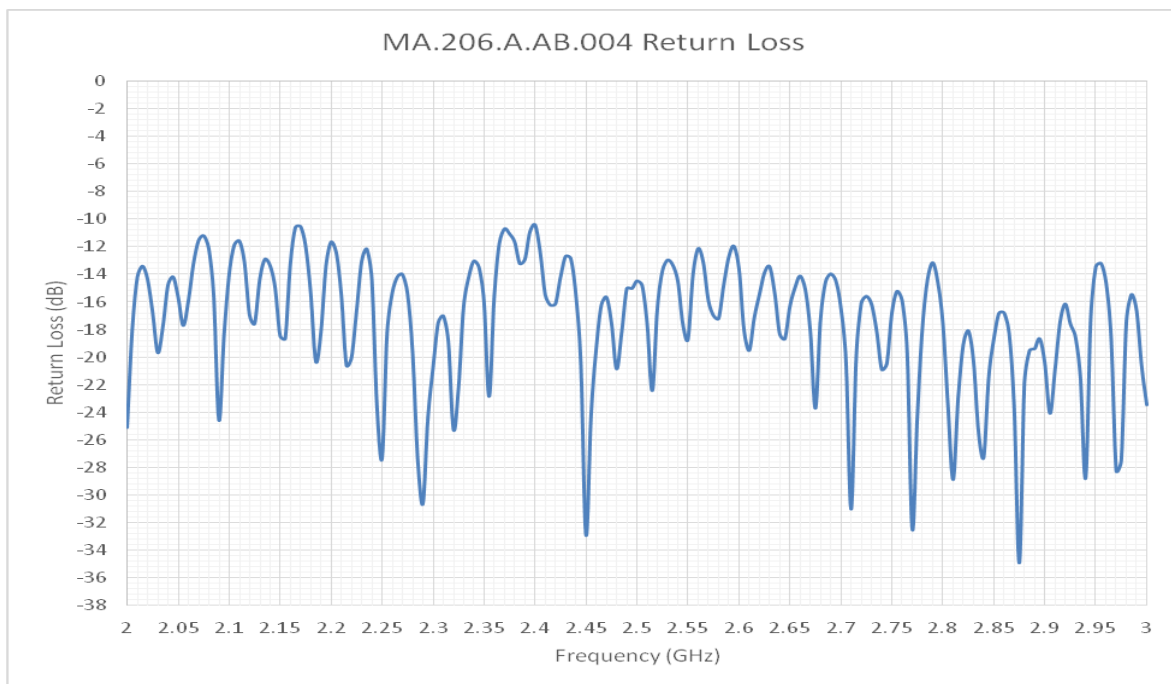

3.3 Efficiency (2.4~2.5GHz Antenna)

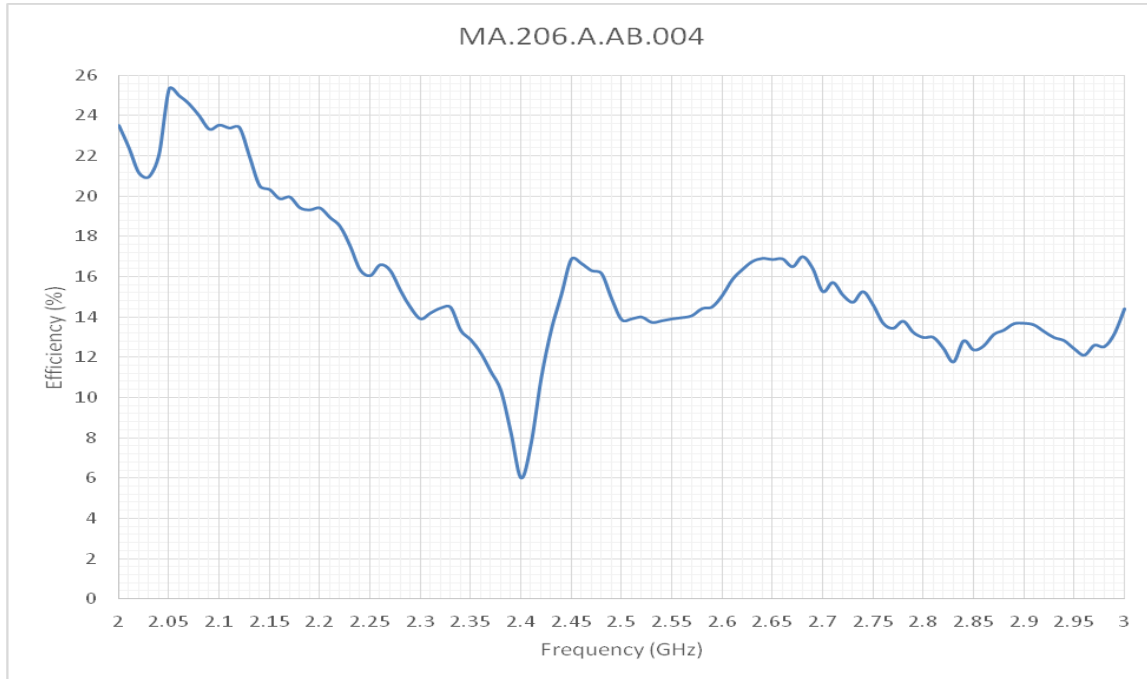

3.4 Peak Gain (2.4~2.5GHz Antenna)

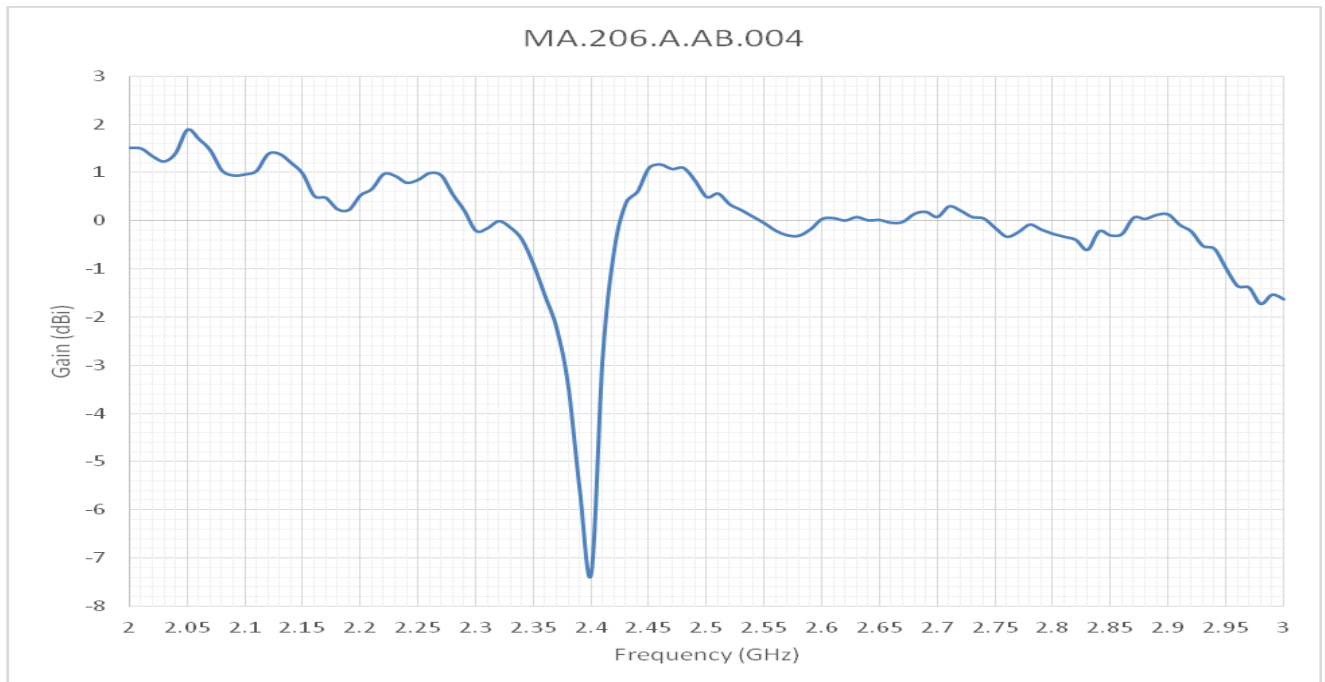

3.5 Radiation Patterns Wi-Fi Antenna

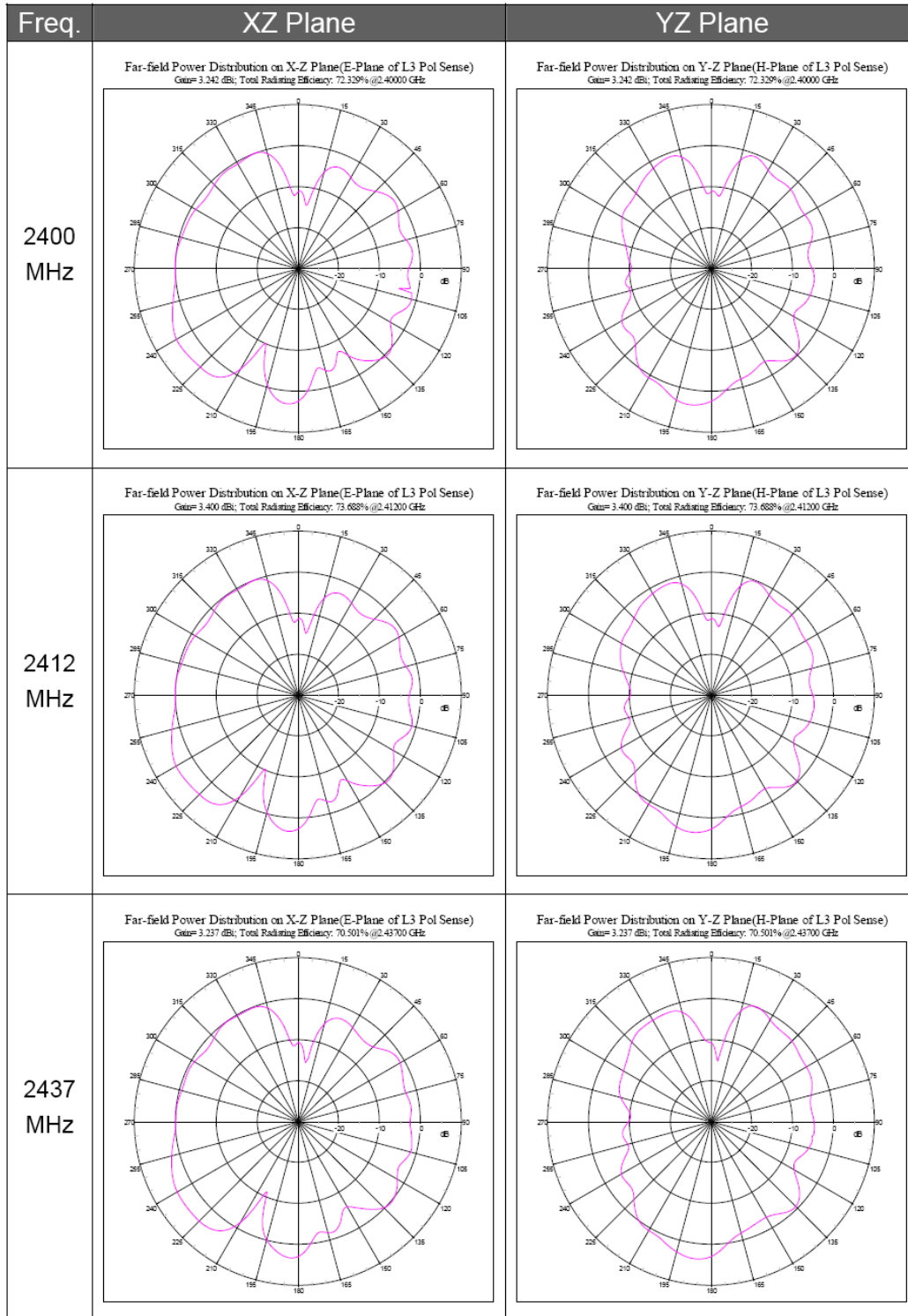

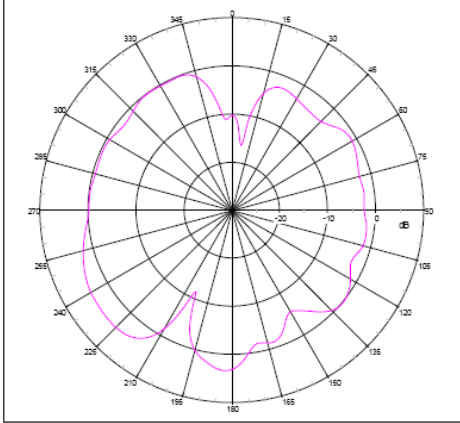
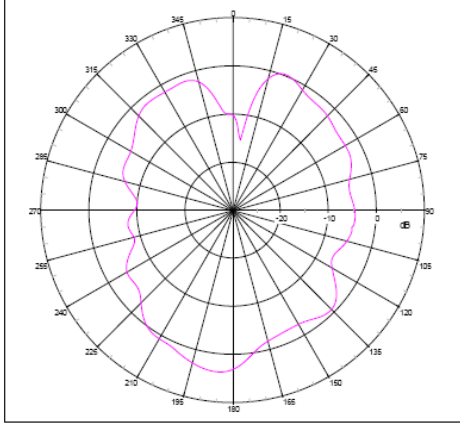
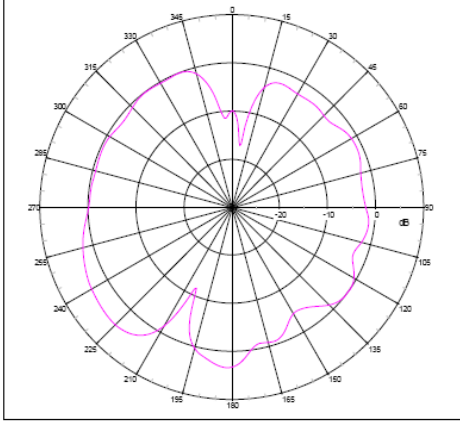
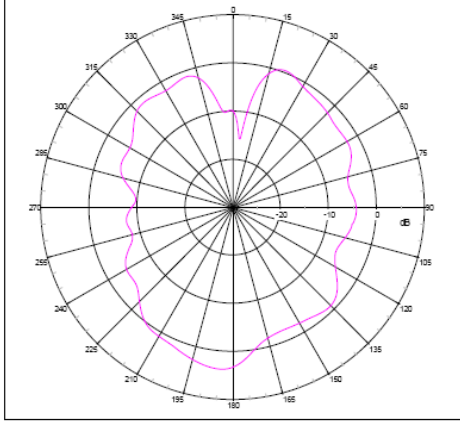
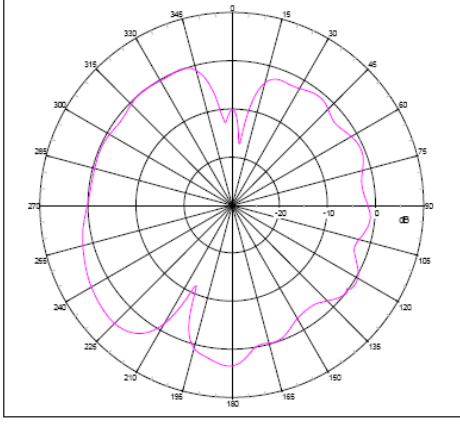
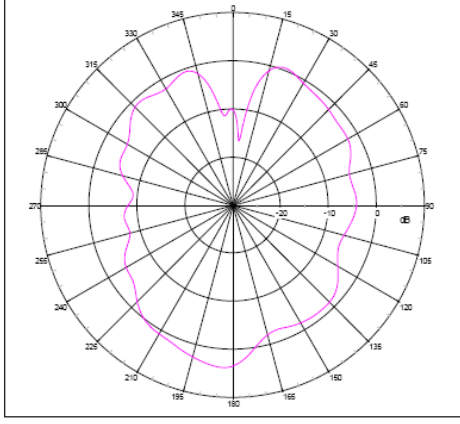
Freq.	XZ Plane	YZ Plane
2450 MHz	<p>Far-field Power Distribution on X-Z Plane(E-Plane of L3 Pol Sense) Gain= 3.171 dBi; Total Radiating Efficiency: 72.553% @2.45000 GHz</p> 	<p>Far-field Power Distribution on Y-Z Plane(H-Plane of L3 Pol Sense) Gain= 3.171 dBi; Total Radiating Efficiency: 72.553% @2.45000 GHz</p> 
2472 MHz	<p>Far-field Power Distribution on X-Z Plane(E-Plane of L3 Pol Sense) Gain= 3.176 dBi; Total Radiating Efficiency: 69.163% @2.47200 GHz</p> 	<p>Far-field Power Distribution on Y-Z Plane(H-Plane of L3 Pol Sense) Gain= 3.176 dBi; Total Radiating Efficiency: 69.163% @2.47200 GHz</p> 
2500 MHz	<p>Far-field Power Distribution on X-Z Plane(E-Plane of L3 Pol Sense) Gain= 3.328 dBi; Total Radiating Efficiency: 66.901% @2.50000 GHz</p> 	<p>Far-field Power Distribution on Y-Z Plane(H-Plane of L3 Pol Sense) Gain= 3.328 dBi; Total Radiating Efficiency: 66.901% @2.50000 GHz</p> 

4. Electrical Characteristic – GPS /GALILEO

4.1 Return Loss

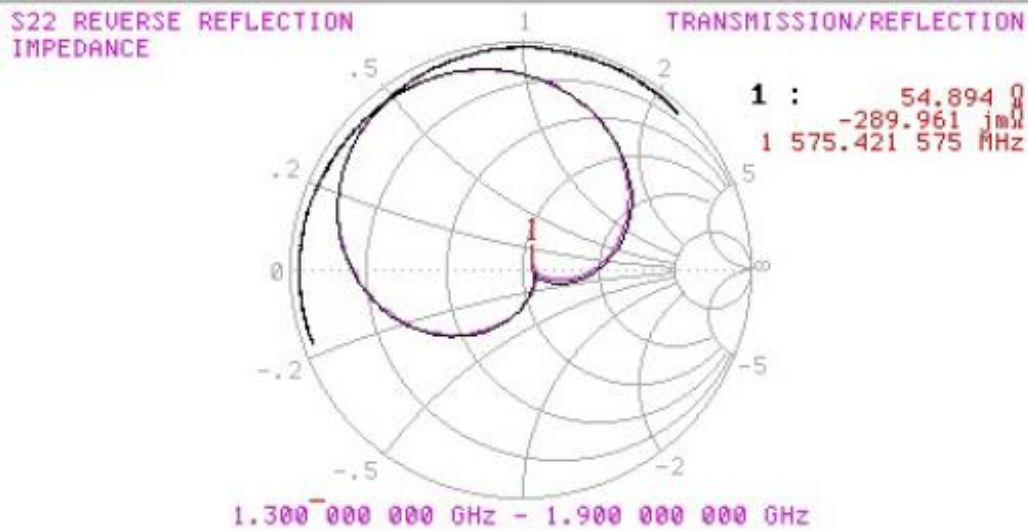
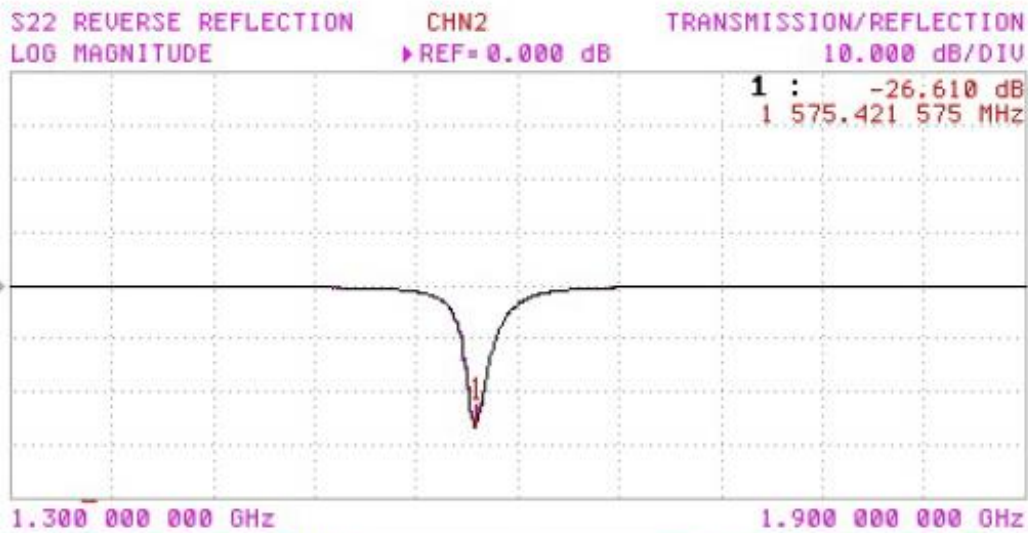

4.2 Radiation Patterns

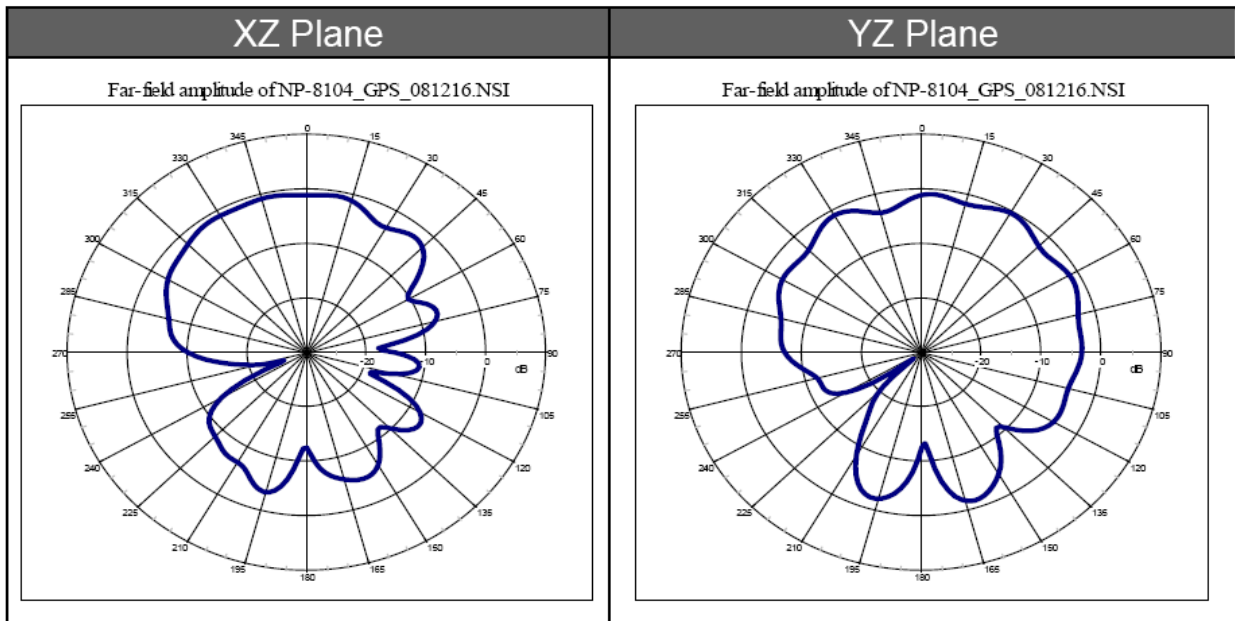
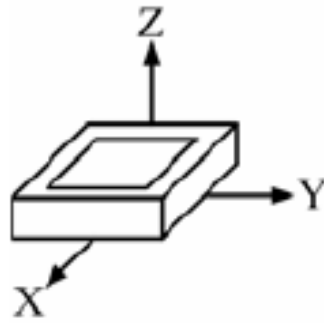

4.3 LNA S22

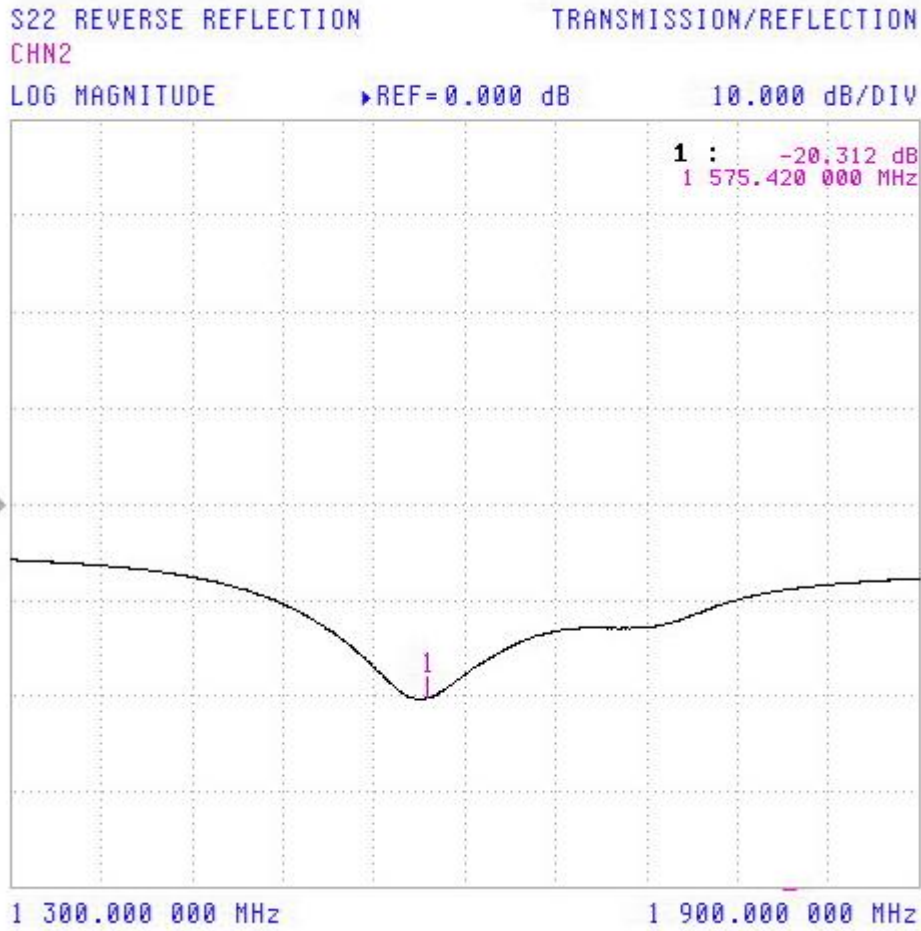

4.3 LNA S21

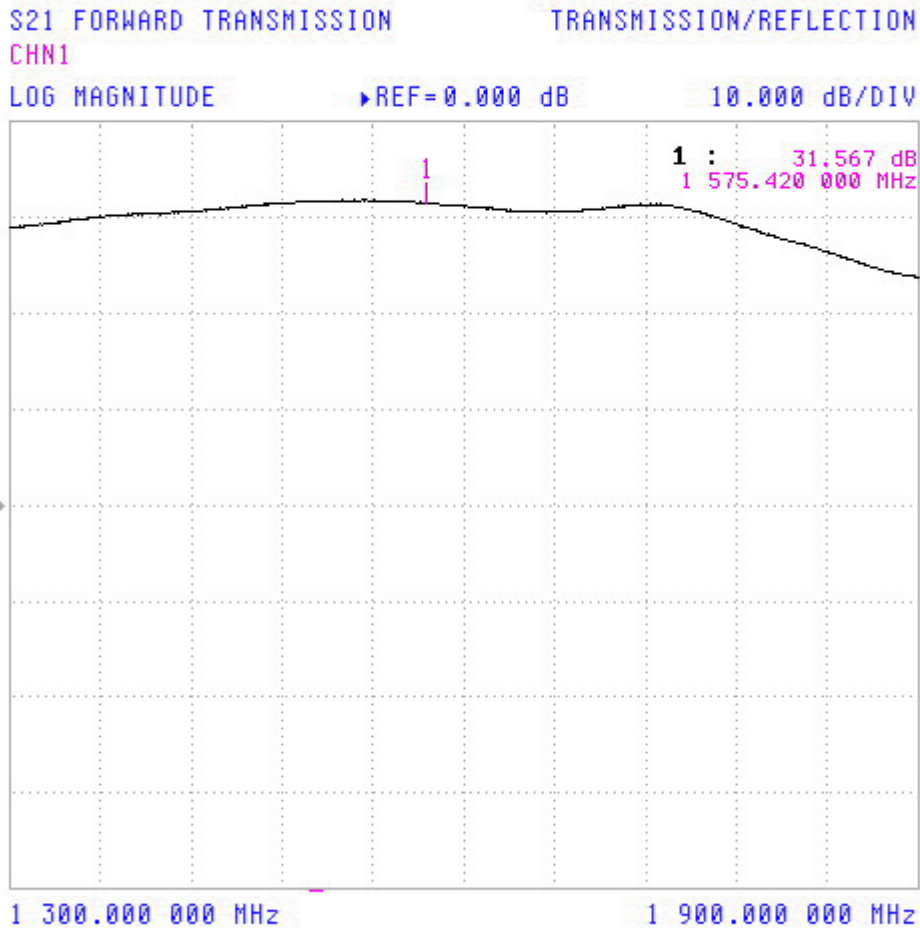

4.4 Noise Figure

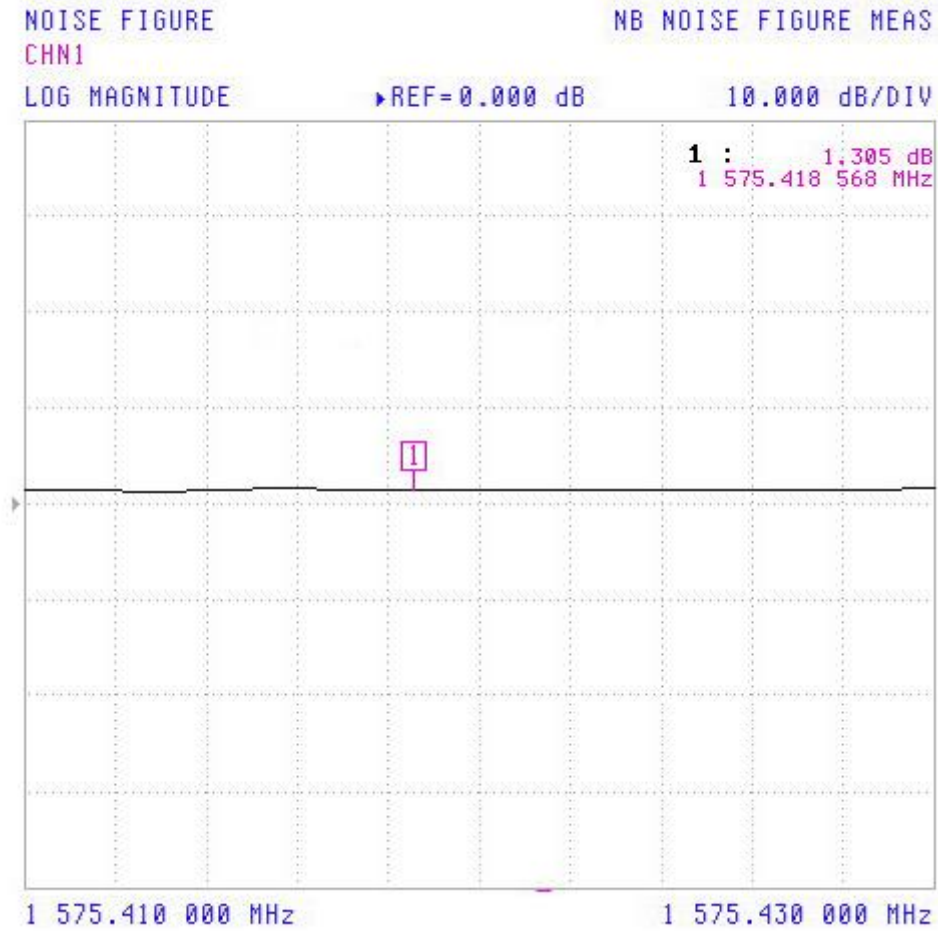

5. Drawings

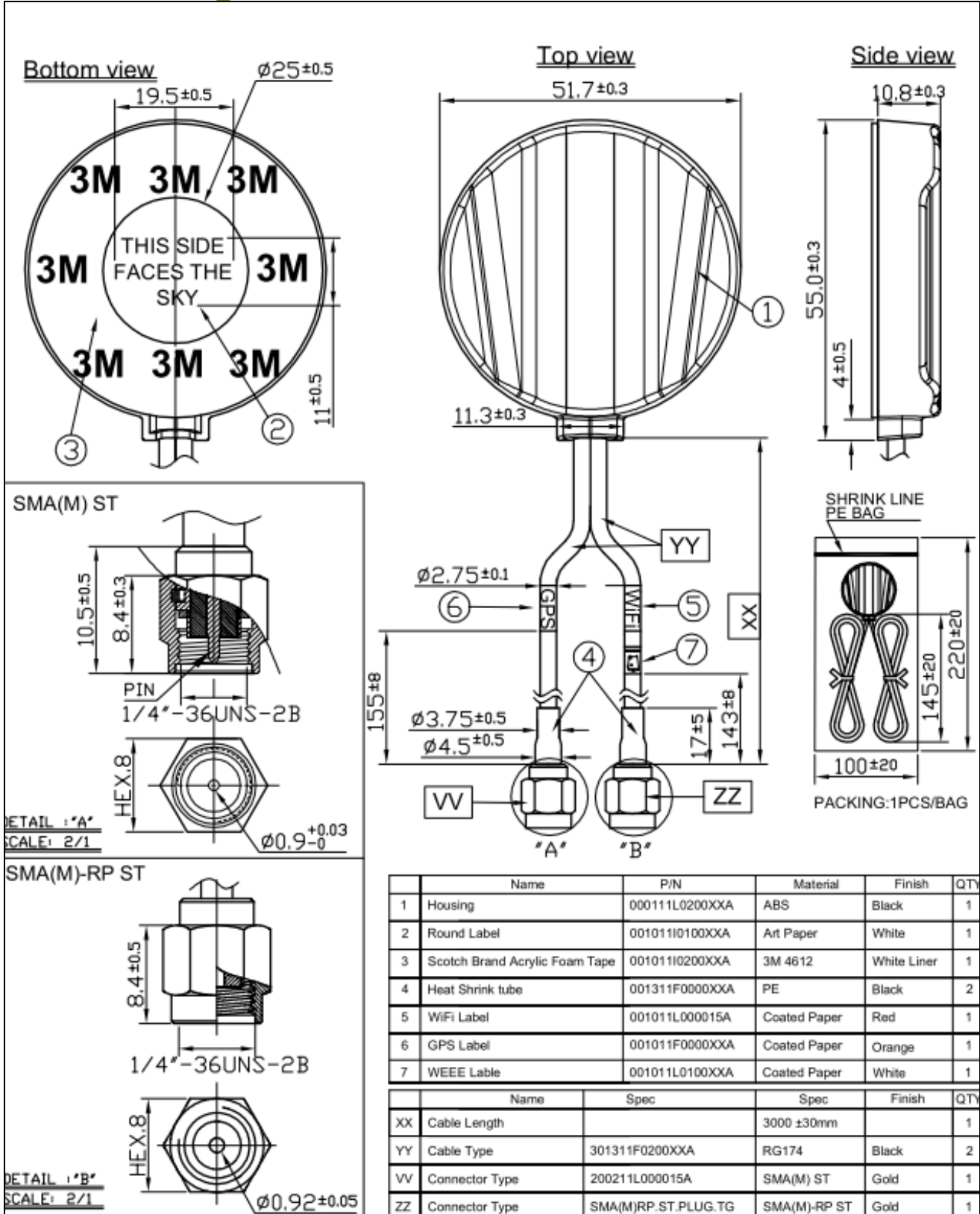

6. Packaging

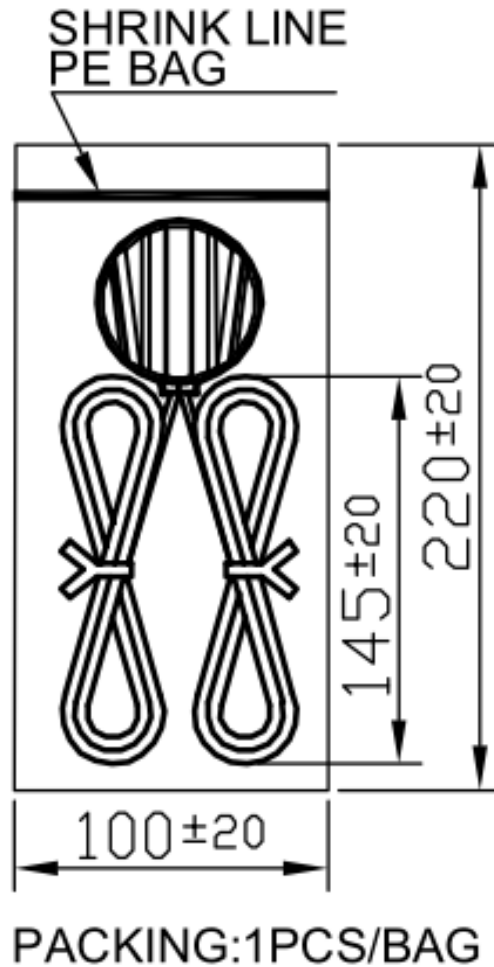

Taoglas makes no warranties based on the accuracy or completeness of the contents of this document and reserves the right to make changes to specifications and product descriptions at any time without notice. Taoglas reserves all rights to this document and the information contained herein.

Reproduction, use or disclosure to third parties without express permission is strictly prohibited.

Copyright © Taoglas Ltd.