



**DESCRIPTION**

The IS354 and IS354A optically coupled isolators each consists of two infrared light emitting diodes in reverse parallel connection allowing AC input voltage and optically coupled to an NPN silicon photo transistor in a space efficient Mini Flat Package.

**FEATURES**

- AC Isolation Voltage 3750V<sub>RMS</sub>
- Wide Operating Temperature Range -55°C to +100°C
- Lead Free and RoHS Compliant
- UL File E91231 Package Code "FPA1"

**APPLICATIONS**

- Computer Terminals
- Industrial System Controllers
- Measuring Instruments
- System Appliances

**ORDER INFORMATION**

- Available in Tape and Reel

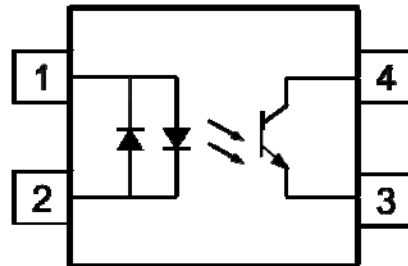

**ABSOLUTE MAXIMUM RATINGS (T<sub>A</sub> = 25°C)**

Stresses exceeding the absolute maximum ratings can cause permanent damage to the device. Exposure to absolute maximum ratings for long periods of time can adversely affect reliability.

**Input**

Forward Current	±50mA
Power dissipation	70mW

**Output**

Collector to Emitter Voltage BV <sub>CEO</sub>	35V
Emitter to Collector Voltage BV <sub>ECO</sub>	6V
Collector Current	50mA
Power Dissipation	150mW

**Total Package**

Isolation Voltage	3750V <sub>RMS</sub>
Total Power Dissipation	170mW
Operating Temperature	-55 to 100 °C
Storage Temperature	-55 to 150 °C
Lead Soldering Temperature (10s)	260°C

**ISOCOM COMPONENTS 2004 LTD**

Unit 25B, Park View Road West, Park View Industrial Estate  
 Hartlepool, Cleveland, TS25 1PE, United Kingdom  
 Tel : +44 (0)1429 863 609 Fax : +44 (0)1429 863 581  
 e-mail : sales@isocom.co.uk  
<http://www.isocom.com>

**ISOCOM COMPONENTS ASIA LTD**

Hong Kong Office,  
 Block A, 8/F, Wah Hing Industrial mansion,  
 36 Tai Yau Street, San Po Kong, Kowloon, Hong Kong.  
 Tel : +852 2995 9217 Fax : +852 8161 6292  
 e-mail : sales@isocom.com.hk



**IS354 / IS354A**

**ELECTRICAL CHARACTERISTICS (Ambient Temperature = 25°C unless otherwise specified)**

**INPUT**

Parameter	Symbol	Test Condition	Min	Typ.	Max	Unit
Forward Voltage	$V_F$	$I_F = \pm 20\text{mA}$		1.2	1.4	V
Terminal Capacitance	$C_t$	$V = 0\text{V}, f = 1\text{KHz}$		30	250	pF

**OUTPUT**

Parameter	Symbol	Test Condition	Min	Typ.	Max	Unit
Collector - Emitter Breakdown Voltage	$BV_{CEO}$	$I_C = 0.1\text{mA}, I_F = 0\text{mA}$	35			V
Emitter - Collector Breakdown Voltage	$BV_{ECO}$	$I_E = 10\mu\text{A}, I_F = 0\text{mA}$	6			V
Collector - Emitter Dark Current	$I_{CEO}$	$V_{CE} = 20\text{V}, I_F = 0\text{mA}$			100	nA

**COUPLED**

Parameter	Symbol	Test Condition	Min	Typ.	Max	Unit
Current Transfer Ratio	CTR	$I_F = \pm 1\text{mA}, V_{CE} = 5\text{V}$	20		400	%
		Optional CTR Grades A	50		150	
Collector - Emitter Saturation Voltage	$V_{CE(sat)}$	$I_F = \pm 20\text{mA}, I_C = 1\text{mA}$			0.2	V
Input to Output Isolation Voltage	$V_{ISO}$	R.H. = 40% - 60%, 1 minute Note 1	3750			$V_{RMS}$
Input to Output Isolation Resistance	$R_{ISO}$	$V_{IO} = 500\text{V}, \text{R.H.} = 40\% \text{ to } 60\%$ Note 1	$5 \times 10^{10}$			$\Omega$
Floating Capacitance	$C_f$	$V = 0\text{V}, f = 1\text{MHz}$		0.6	1	pF
Output Rise Time	$t_r$	$V_{CE} = 2\text{V}, I_C = 2\text{mA}, R_L = 100\Omega$		4	18	$\mu\text{s}$
Output Fall Time	$t_f$			3	18	$\mu\text{s}$

Note 1 : Measure with input leads shorted together and output leads shorted together.

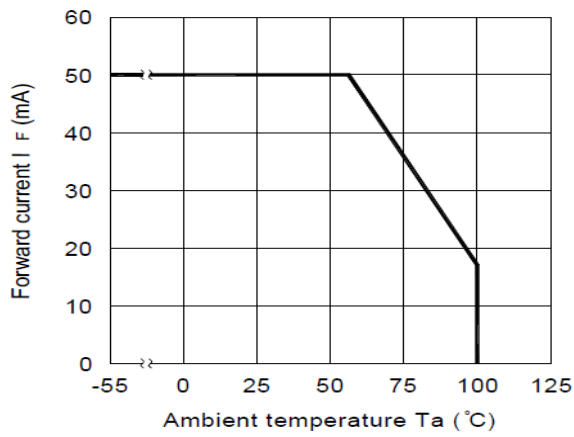

Fig 1 Forward Current vs  $T_A$

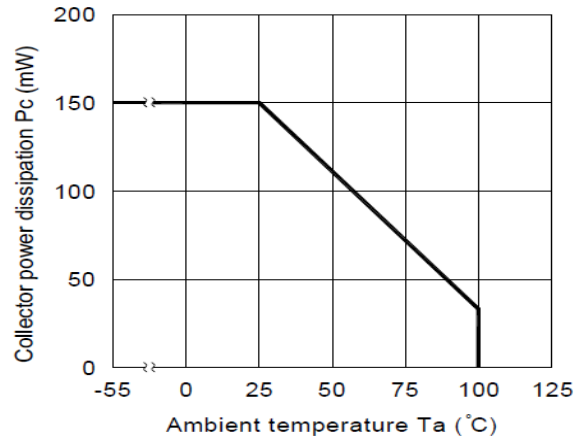

Fig 2 Collector Power Dissipation vs  $T_A$

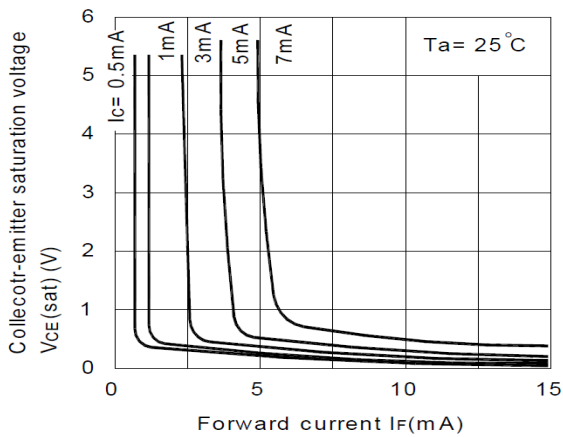

Fig 3 Collector-emitter Saturation Voltage vs Forward Current

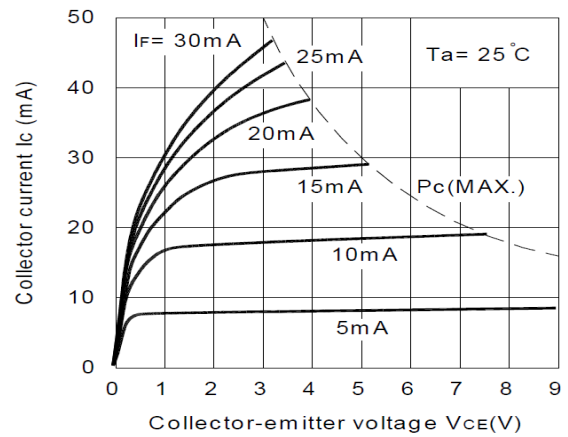

Fig 4 Collector Current vs Collector-emitter Voltage

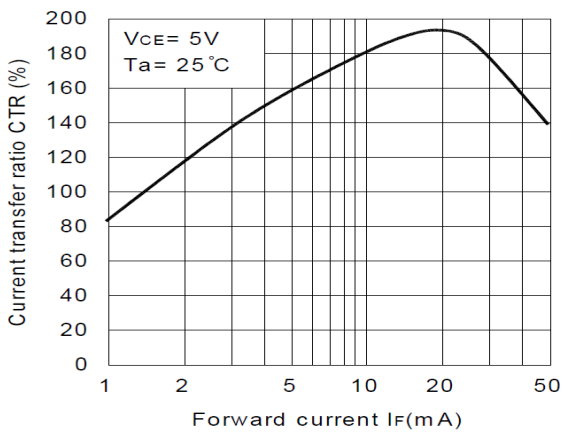

Fig 5 Current Transfer Ratio vs Forward Current

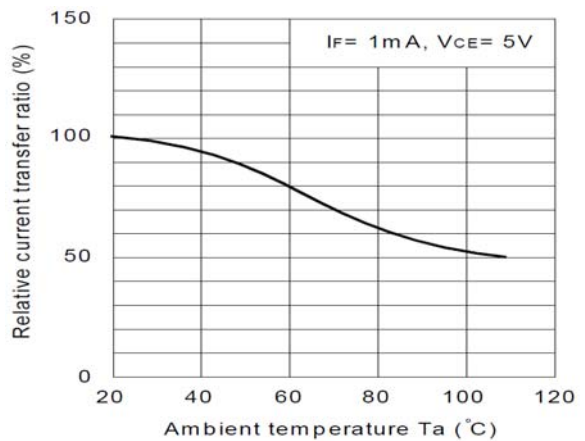
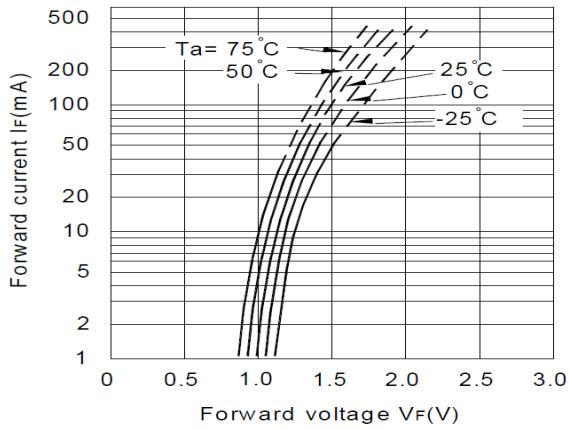
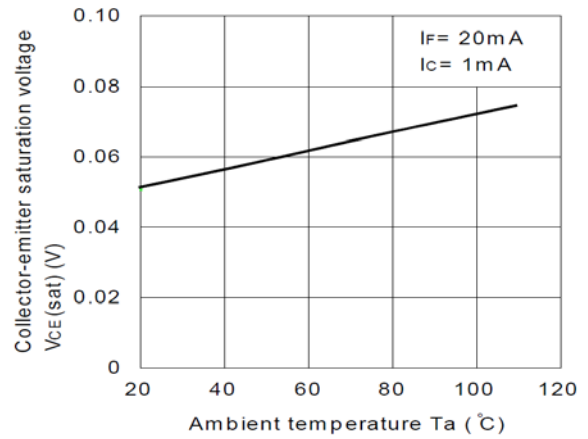

Fig 6 Relative Current Transfer Ratio vs  $T_A$

## IS354 / IS354A



**Fig 7 Forward Current vs Forward Voltage**



**Fig 8 Collector-emitter Saturation Voltage vs  $T_A$**

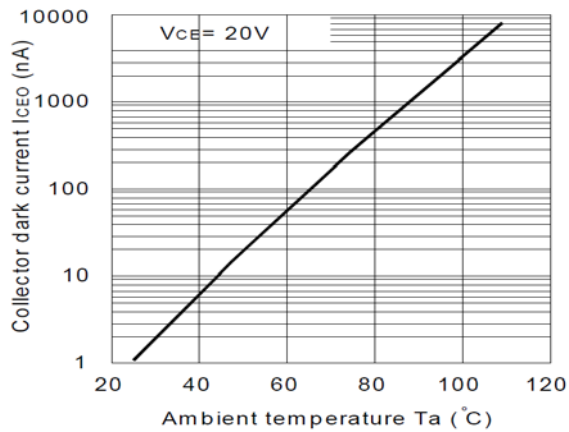

**Fig 9 Collector Dark Current vs  $T_A$**

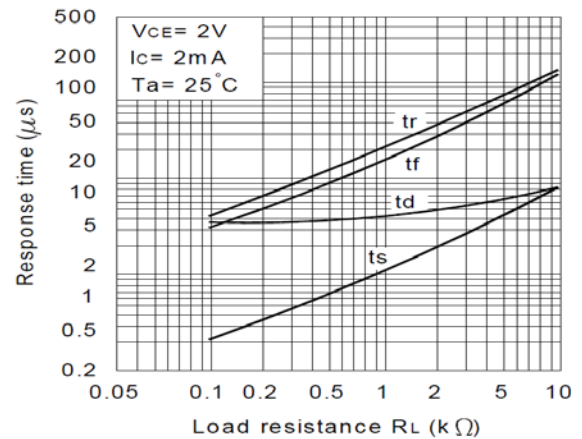

**Fig 10 Response Time vs Load Resistance**

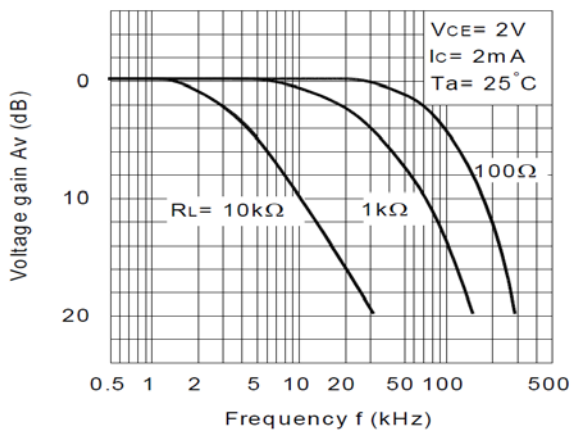

**Fig 11 Frequency Response**

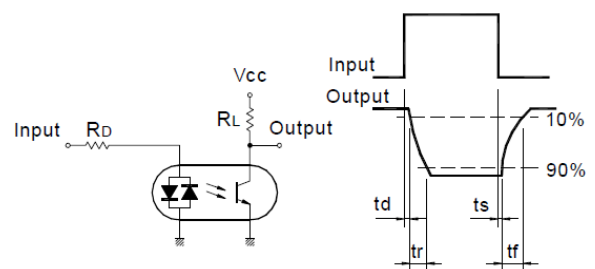

**Response Time Test Circuit**

## IS354 / IS354A

### ORDER INFORMATION

IS354, IS354A			
After PN	PN	Description	Packing quantity
None	IS354, IS354A	Surface Mount Tape & Reel	3000 pcs per reel

### DEVICE MARKING

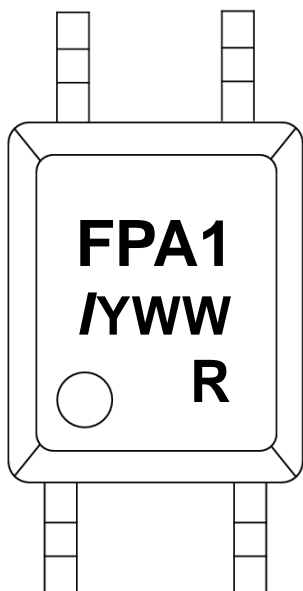

FPA1	denotes Device Part Number
/	denotes Isocom
Y	denotes 1 digit Year code
WW	denotes 2 digit Week code
R	denotes CTR Grade

**IS354 / IS354A**

**PACKAGE DIMENSIONS (mm)**

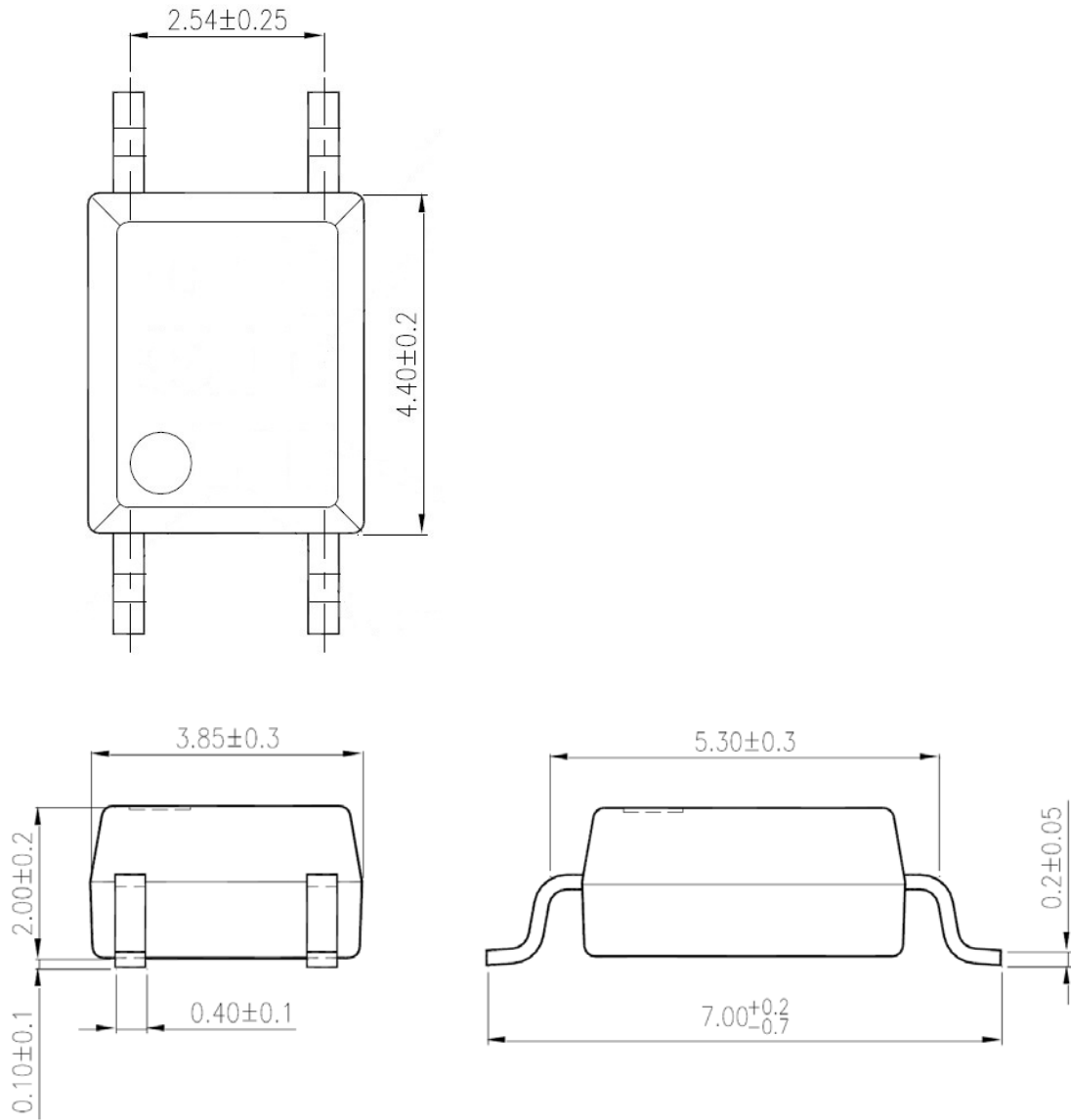



**IS354 / IS354A**

**RECOMMENDED SOLDER PAD LAYOUT (mm)**

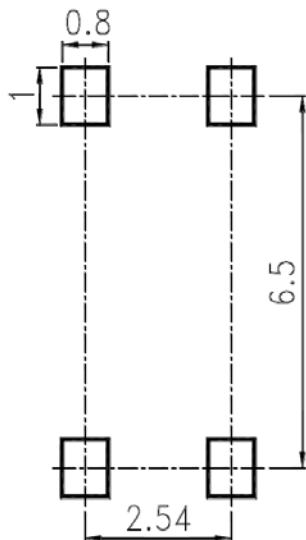

**TAPE AND REEL PACKAGING**

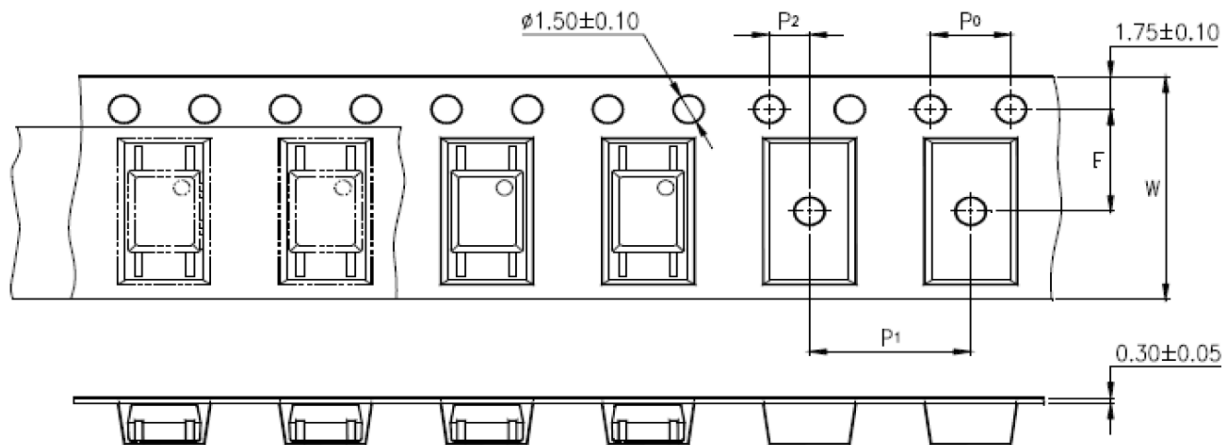

Description	Symbol	Dimension mm (inch)
Tape Width	W	12 ± 0.3 (0.47)
Pitch of Sprocket Holes	P <sub>0</sub>	4 ± 0.1 (0.15)
Distance of Compartment to Sprocket Holes	F	5.5 ± 0.1 (0.217)
	P <sub>2</sub>	2 ± 0.1 (0.079)
Distance of Compartment to Compartment	P <sub>1</sub>	8 ± 0.1 (0.315)

**IR REFLOW SOLDERING TEMPERATURE PROFILE**  
**One Time Reflow Soldering is Recommended.**  
**Do not immerse device body in solder paste.**

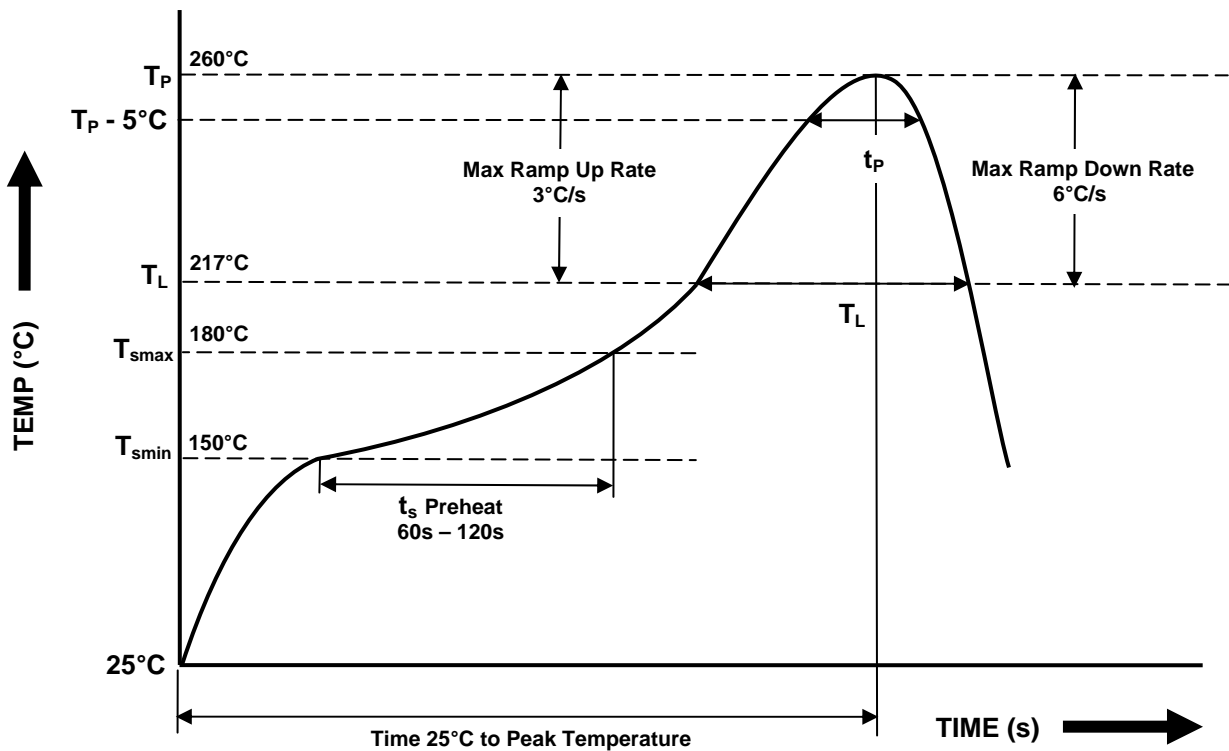

Profile Details	Conditions
<b>Preheat</b> - Min Temperature (T <sub>SMIN</sub> ) - Max Temperature (T <sub>SMAX</sub> ) - Time T <sub>SMIN</sub> to T <sub>SMAX</sub> (t <sub>s</sub> )	150°C 180°C 60s - 120s
<b>Soldering Zone</b> - Peak Temperature (T <sub>P</sub> ) - Liquidous Temperature (T <sub>L</sub> ) - Time within 5°C of Actual Peak Temperature (T <sub>P</sub> - 5°C) - Time maintained above T <sub>L</sub> (t <sub>L</sub> ) - Ramp Up Rate (T <sub>L</sub> to T <sub>P</sub> ) - Ramp Down Rate (T <sub>P</sub> to T <sub>L</sub> )	260°C 217°C 20s 60s 3°C/s max 3 - 6°C/s
Average Ramp Up Rate (T <sub>smax</sub> to T <sub>P</sub> )	3°C/s max
Time 25°C to Peak Temperature	8 minutes max





## Disclaimer

Isocom Components is continually working to improve the quality and reliability of its products. Nevertheless, semiconductor devices in general can malfunction or fail due to their inherent electrical sensitivity and vulnerability to physical stress. It is the responsibility of the buyer, when utilizing Isocom Components products, to comply with the standards of safety in making a safe design for the entire system, and to avoid situations in which a malfunction or failure of such Isocom Components products could cause loss of human life, bodily injury or damage to property.

In developing your designs, please ensure that Isocom Components products are used within specified operating ranges as set forth in the most recent Isocom Components products specifications.

The Isocom Components products listed in this document are intended for usage in general electronics applications (computer, personal equipment, office equipment, measuring equipment, industrial robotics, domestic appliances, etc.). These Isocom Components products are neither intended nor warranted for usage in equipment that requires extraordinarily high quality and/or reliability or a malfunction or failure of which may cause loss of human life or bodily injury ("Unintended Usage"). Unintended Usage include atomic energy control instruments, airplane or spaceship instruments, transportation Instruments, traffic signal instruments, combustion control instruments, medical Instruments, all types of safety devices, etc... Unintended Usage of Isocom Components products listed in this document shall be made at the customer's own risk.

Gallium arsenide (GaAs) is a substance used in the products described in this document. GaAs dust and fumes are toxic. Do not break, cut or pulverize the product, or use chemicals to dissolve them. When disposing of the products, follow the appropriate regulations. Do not dispose of the products with other industrial waste or with domestic garbage.

The products described in this document are subject to the foreign exchange and foreign trade laws.

The information contained herein is presented only as a guide for the applications of our products. No responsibility is assumed by Isocom Components for any infringements of intellectual property or other rights of the third parties which may result from its use. No license is granted by implication or otherwise under any intellectual property or other rights of Isocom Components or others.

The information contained herein is subject to change without notice.