



Grayhill, Inc.

## 62S11-N9-060C

Broj dela:

62S11-N9-060C

Proizvođač / robna marka:

Grayhill, Inc.

Opis proizvoda

ROTARY ENCODER OPTICAL 32PPR

Datasheets:

 62S11-N9-060C.pdf

Status RoHS

 Bez olova / RoHS Compliant

Stanje zaliha

2192 pcs stock

Ship From

hong kong

Shipment Way

DHL/Fedex/TNT/UPS/EMS

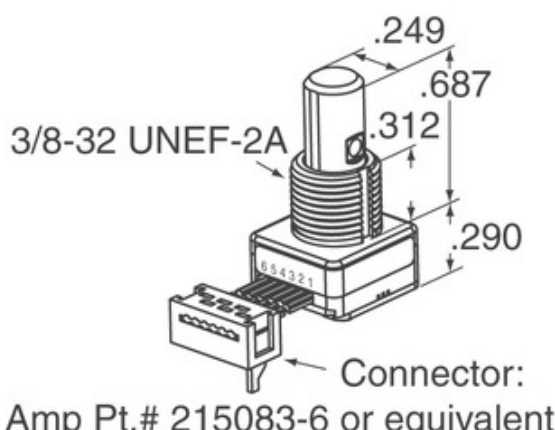

Slika može biti reprezentativna. Pogledajte specifikacije za detalje o proizvodu.

[REQUEST FOR QUOTATION](#)







### Specifikacije 62S11-N9-060C

BROJ DELA	62S11-N9-060C
PROIZVOĐAČ	Grayhill, Inc.
OPIS	ROTARY ENCODER OPTICAL 32PPR
STATUS BEZ VODE / ROHS STATUS	Bez olova / RoHS Compliant
DOSTUPNA KOLIČINA	2192 pcs
TEHNIČKI LIST	 62S11-N9-060C.pdf
NAPON - SNABDEVANJE	5V
TERMINATION STYLE	Cable with Connector
SERIES	62S
ROTACIJSKI ŽIVOT (CIKLUSI MIN)	1M
PULSEVI PO REVOLUCIJI	32
IZLAZNI TIP	Quadrature (Incremental)
DRUGE NAZIVE	62S11N9060C
ORIJENTACIJA	Vertical
TIP MONTAŽE	Panel Mount
NIVO OSETLJIVOSTI NA VLAGU (MSL)	1 (Unlimited)
STATUS BEZ VODE / ROHS STATUS	Lead free / RoHS Compliant
TIP ENKODERA	Optical
PRITVOR	No
UGRAĐENI PREKIDAČ	Yes
VRSTA AKTUATORA	1/4" Dia Flatted End

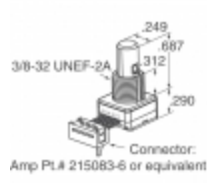
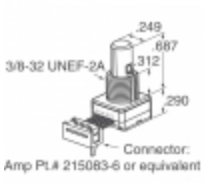
### Povezane oznake

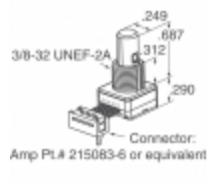
Grayhill, Inc. 62S11-N9-060C	62S11-N9-060C Distributor	62S11-N9-060C Supplier
62S11-N9-060C Cijena	62S11-N9-060C Pictures	Slika 62S11-N9-060C
62S11-N9-060C PDF Datasheet	62S11-N9-060C Preuzimanje Datasheet	62S11-N9-060C Datasheet
62S11-N9-060C Stock	Kupi 62S11-N9-060C	Kupi Grayhill, Inc. 62S11-N9-060C
Grayhill, Inc. 62S11-N9-060C	Grayhill, Inc. Supplier	Grayhill, Inc. Distributor
Grayhill, Inc. 62S11-N9-060C	Grayhill Inc. 62S11-N9-060C	

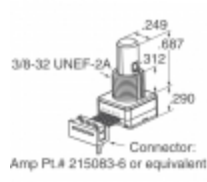
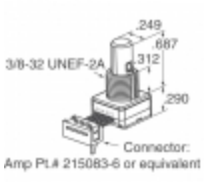
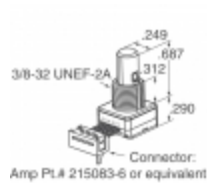
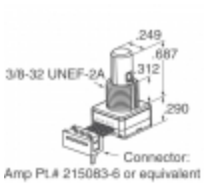
### Srodni proizvodi

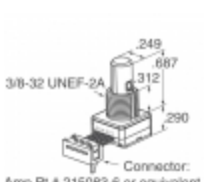
 <p><b>62S11-N5-060SH</b> Proizvođači: Grayhill, Inc. Opis: ROTARY ENCODER OPTICAL 32PPR In stock: 2263 pcs</p> <p><a href="#">RFQ</a></p>	 <p><b>62S11-N9-060SH</b> Proizvođači: Grayhill, Inc. Opis: ROTARY ENCODER OPTICAL 32PPR In stock: 1801 pcs</p> <p><a href="#">RFQ</a></p>
 <p><b>62S15-H0-020C</b> Proizvođači: Grayhill, Inc. Opis: ROTARY ENCODER OPTICAL 24PPR In stock: 2286 pcs</p> <p><a href="#">RFQ</a></p>	 <p><b>62S15-H0-040CH</b> Proizvođači: Grayhill, Inc. Opis: ROTARY ENCODER OPTICAL 24PPR In stock: 1921 pcs</p> <p><a href="#">RFQ</a></p>
 <p><b>62S11-N5-080SH</b> Proizvođači: Grayhill, Inc. Opis: ROTARY ENCODER OPTICAL 32PPR In stock: 1942 pcs</p> <p><a href="#">RFQ</a></p>	 <p><b>62S11-N5-PV</b> Proizvođači: Grayhill, Inc. Opis: ROTARY ENCODER OPTICAL 32PPR In stock: 2220 pcs</p> <p><a href="#">RFQ</a></p>
 <p><b>62S11-N9-PH</b> Proizvođači: Grayhill, Inc. Opis: ROTARY ENCODER OPTICAL 32PPR In stock: 2219 pcs</p> <p><a href="#">RFQ</a></p>	 <p><b>62S11-N5-100C</b> Proizvođači: Grayhill, Inc. Opis: ROTARY ENCODER OPTICAL 32PPR In stock: 1789 pcs</p> <p><a href="#">RFQ</a></p>
 <p><b>62S11-N9-120S</b> Proizvođači: Grayhill, Inc. Opis: ROTARY ENCODER OPTICAL 32PPR In stock: 1784 pcs</p> <p><a href="#">RFQ</a></p>	 <p><b>62S11-N5-120S</b> Proizvođači: Grayhill, Inc. Opis: ROTARY ENCODER OPTICAL 32PPR In stock: 1675 pcs</p> <p><a href="#">RFQ</a></p>
 <p><b>62S15-H0-040C</b> Proizvođači: Grayhill, Inc. Opis: ROTARY ENCODER OPTICAL 24PPR In stock: 1793 pcs</p> <p><a href="#">RFQ</a></p>	 <p><b>62S11-N5-P</b> Proizvođači: Grayhill, Inc. Opis: ROTARY ENCODER OPTICAL 32PPR In stock: 1885 pcs</p> <p><a href="#">RFQ</a></p>

Copyright © 2020 Pouzdan distributer elektroničkih komponenti

E-mail: [Info@infinity-electronic.com](mailto:Info@infinity-electronic.com)

Adresa: 17F, Gaylord Commercial Building, 114-118 Lockhart Road, Wan Chai, Hong Kong

